

NOTA: Desde la lamina 15 se desarrolla cada unidad tipológica

Tema:
 Vivienda Productiva Sostenible
 Quitumbe-Turubamba

Alumno:
 Andrés de la Bastida
 Matrícula:
 119511

Tutor:
 Arq. Patricio Recalde P.

Contenido:
 Planta 2/2 Residencias

Escala:
 1:150

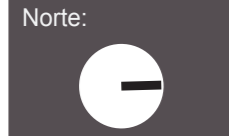

- Simbología:
- D Dormitorio
 - K Cocina
 - C Comedor
 - S Sala
 - BC Baño completo
 - BM Baño Medio
 - T Balcon
 - Vegetación baja

Lámina:
ARQ -

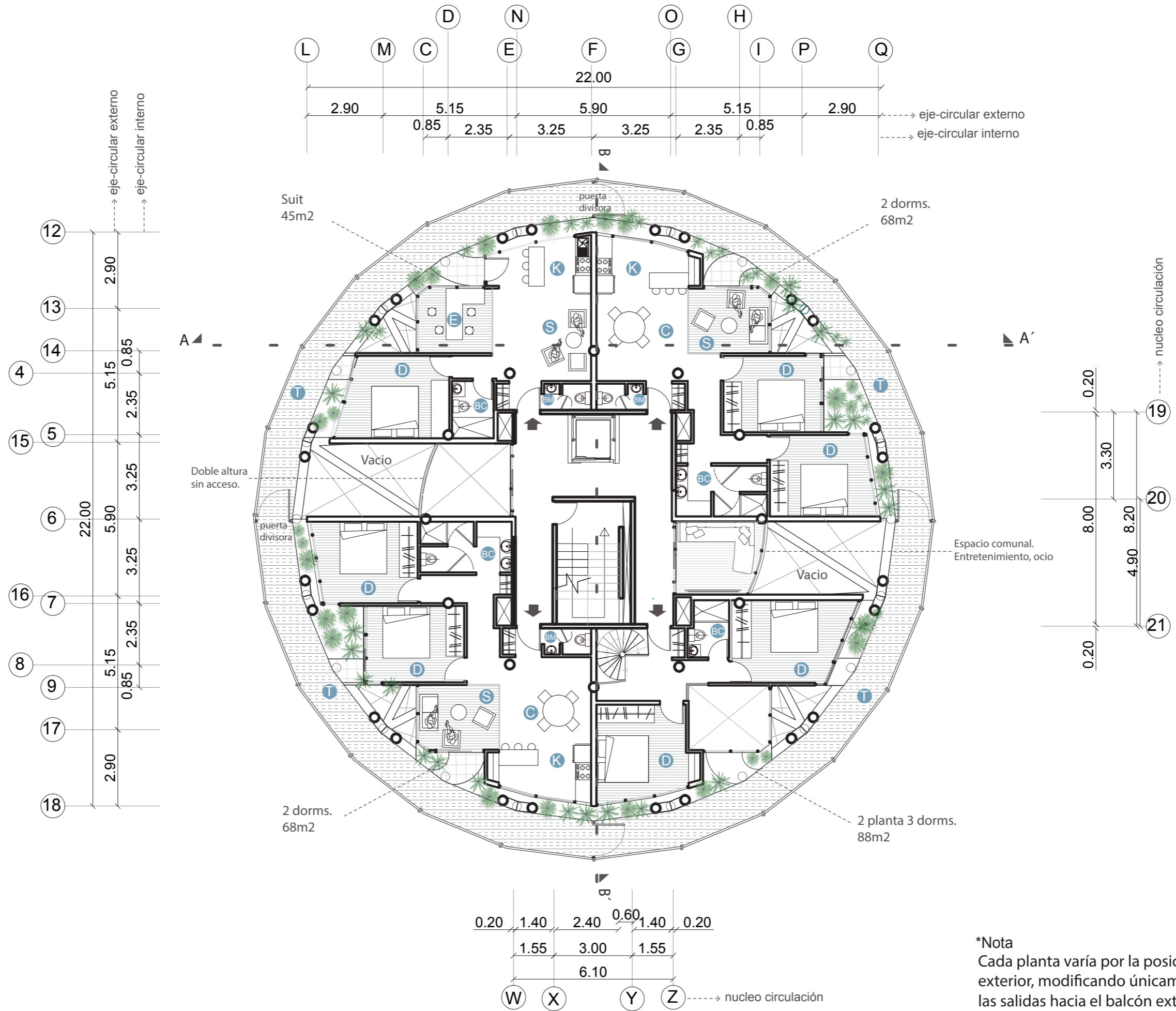

*Nota
 Cada planta varía por la posición de la estructura exterior, modificando únicamente la ubicación de las salidas hacia el balcón exterior.

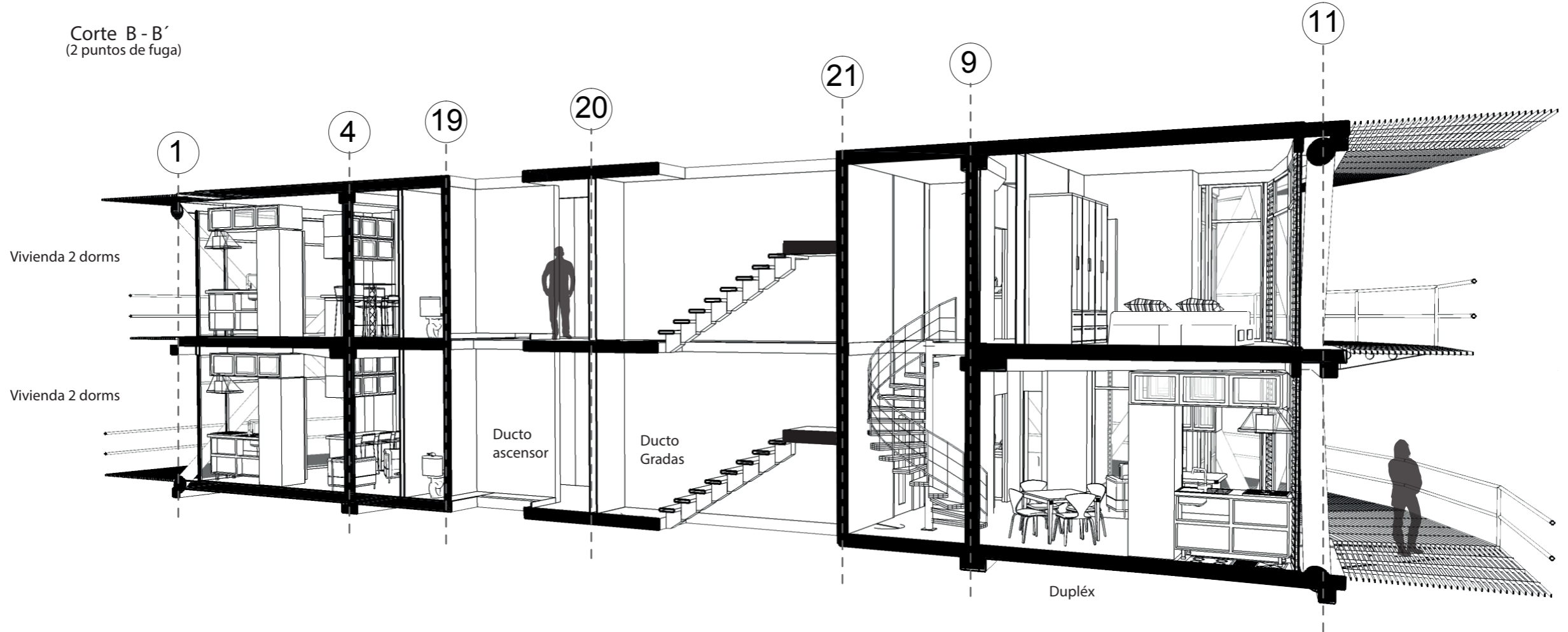
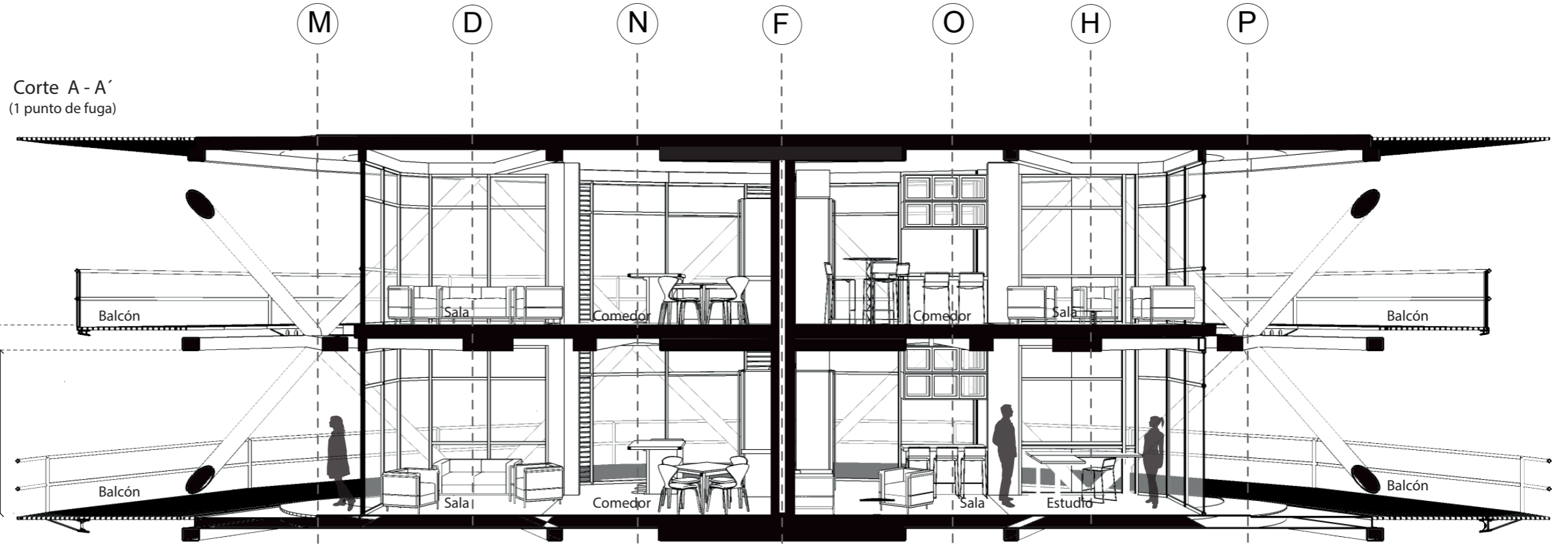



Módulo - Fachada este



Módulo - Fachada sur

Planta
Suit 45m
Tipo 1

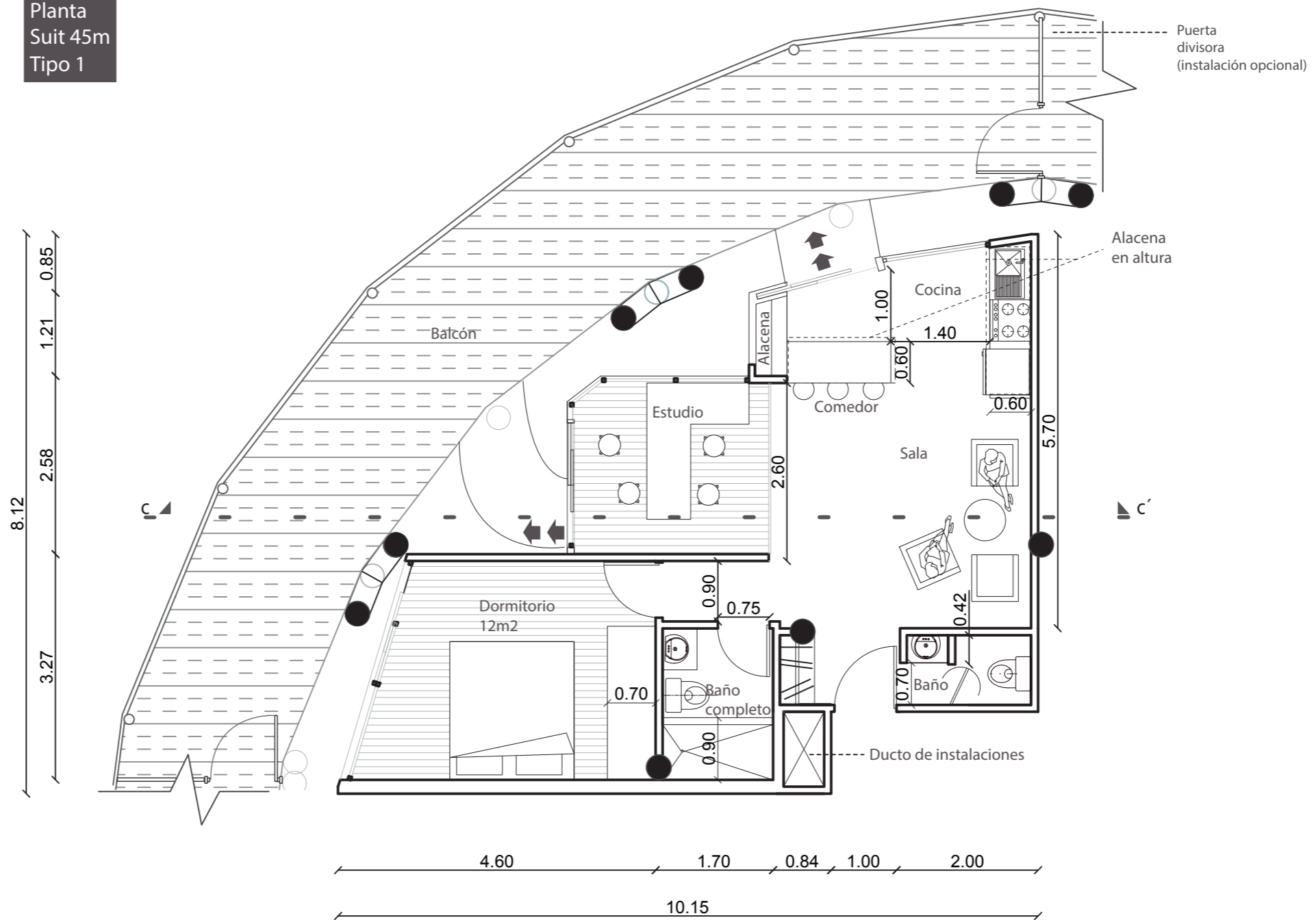

Corte fugado C-C'

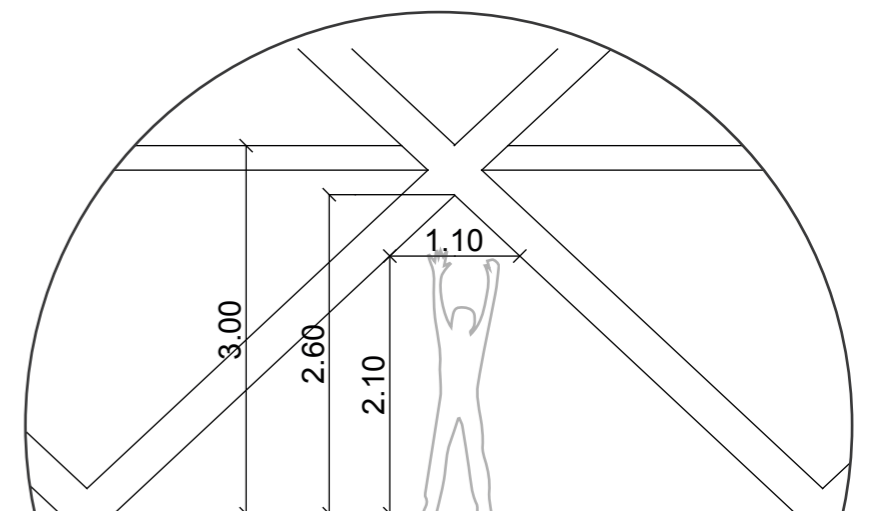
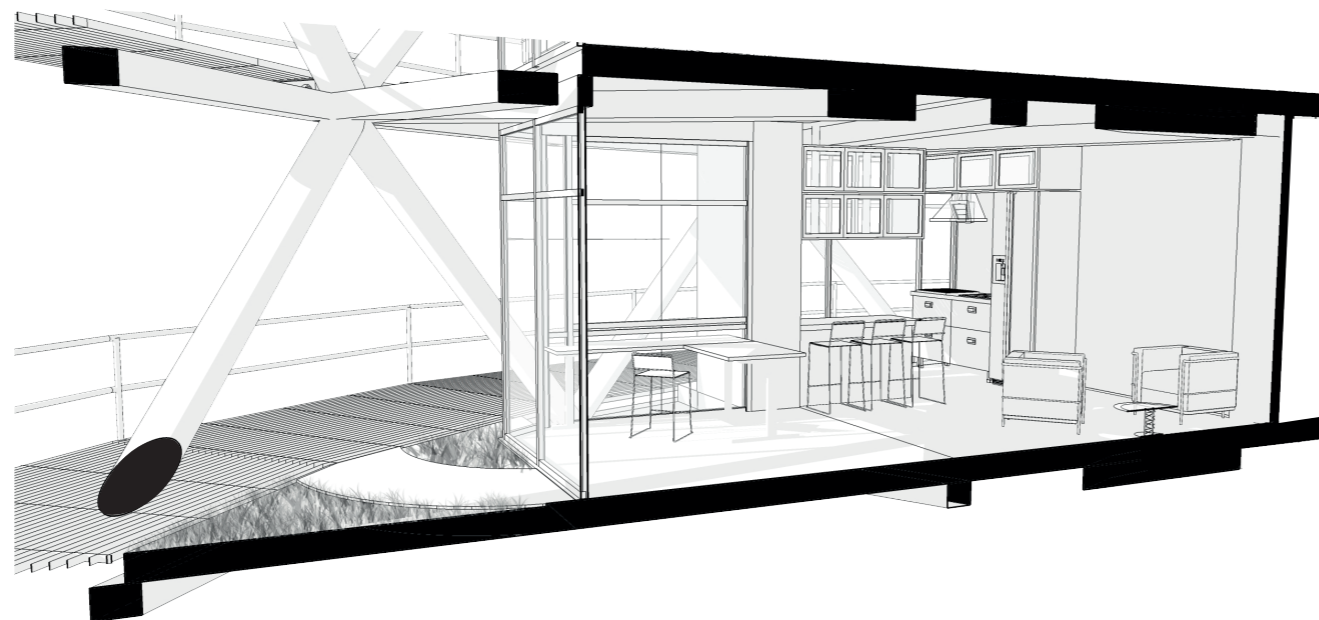

Detalle: Ancho y altura para circulación

Planta
Suit 45m
Tipo 2

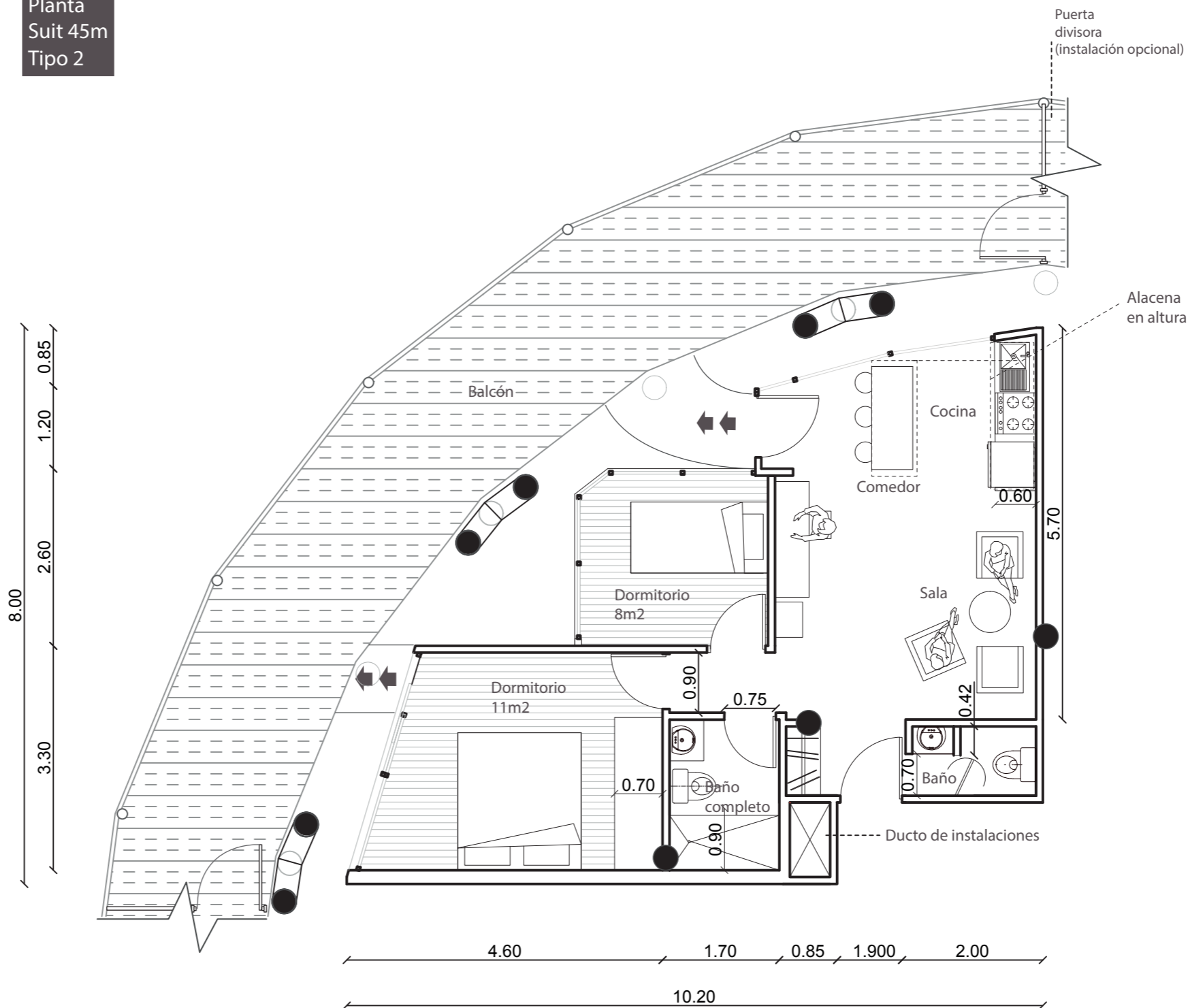

Planta
68m²
Tipo 1

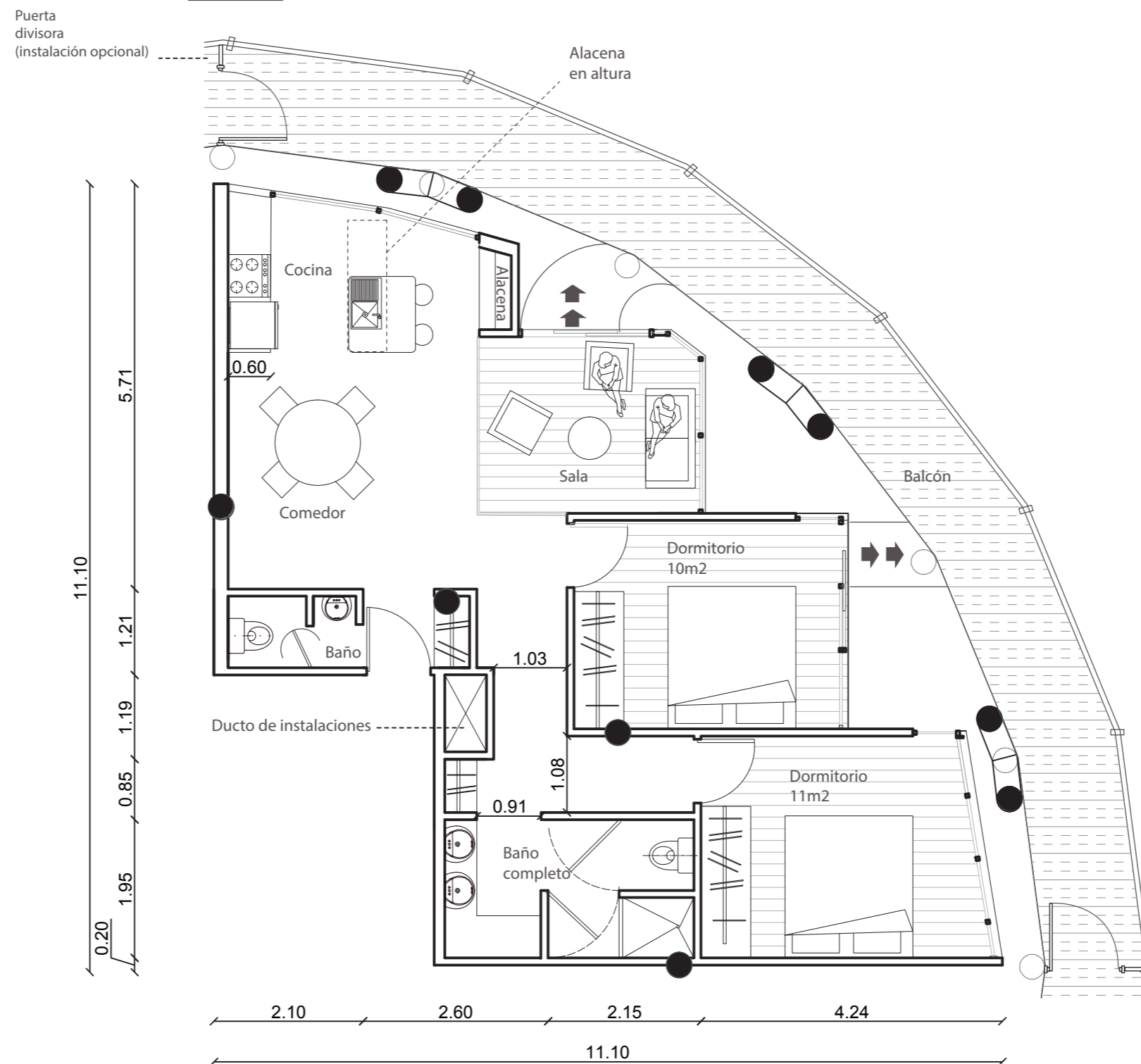

Planta
68m²
Tipo 2

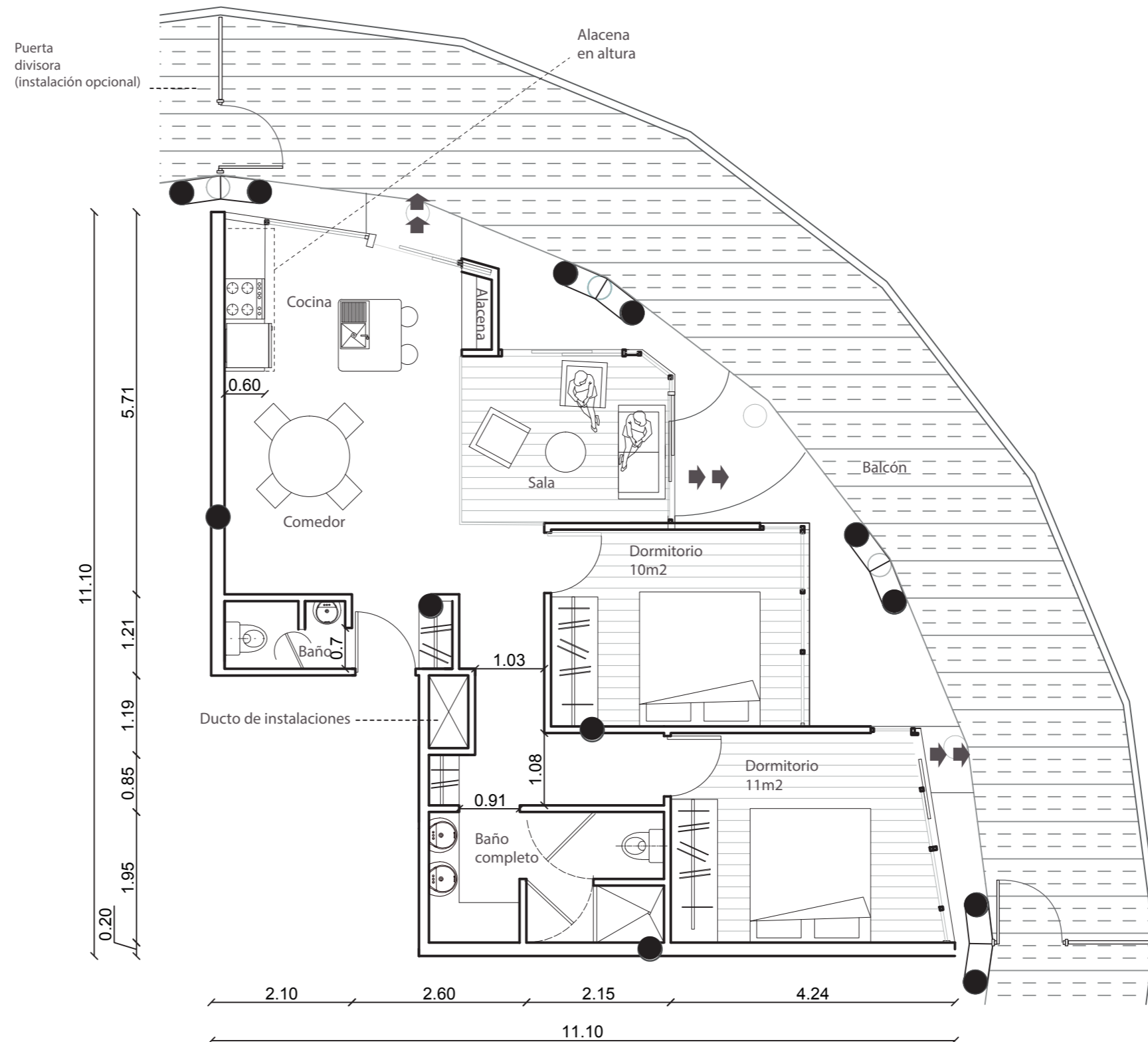

Planta
Duplex 88m2
Primer piso

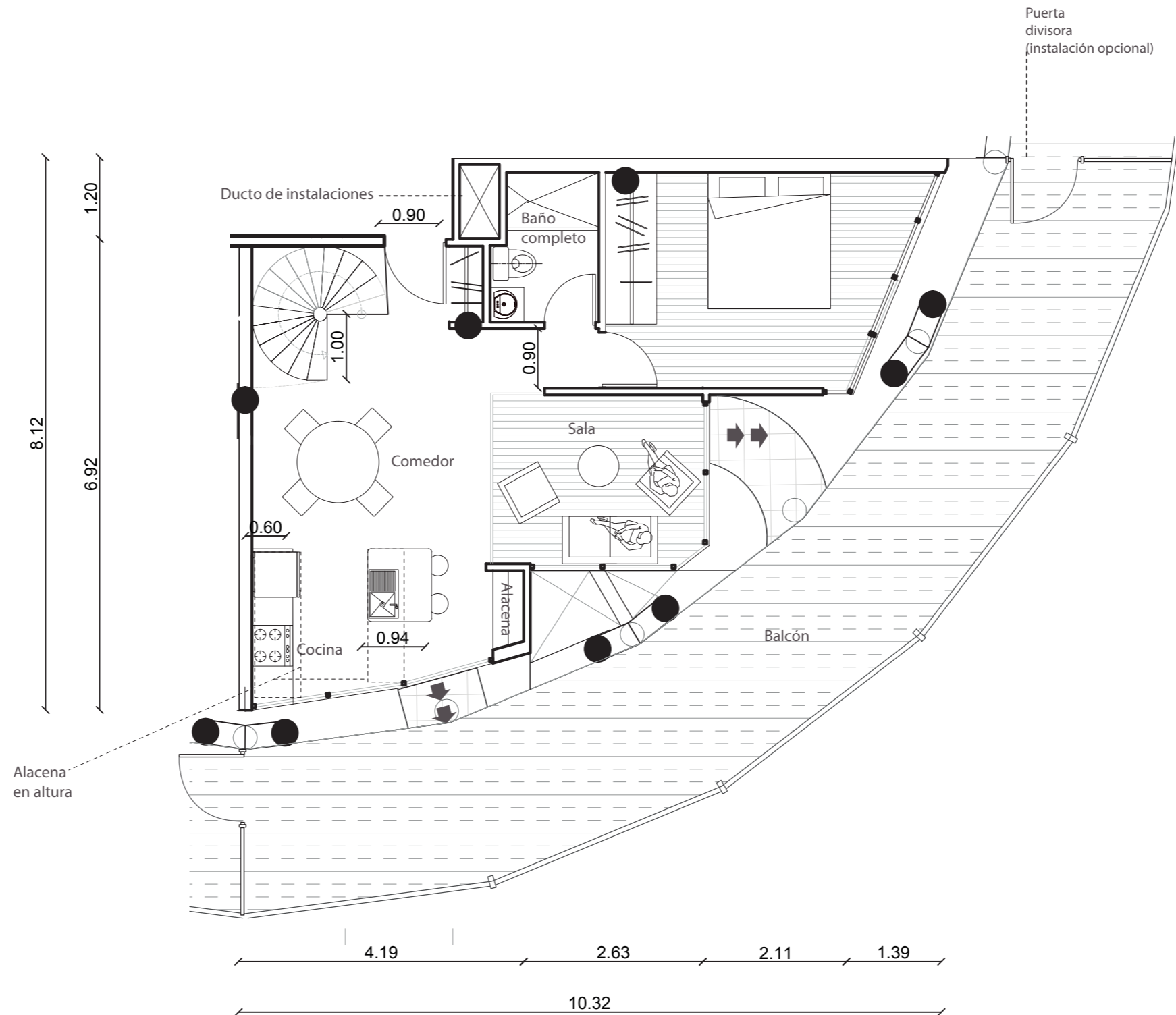

Planta
Duplex 88m2
Sgundo piso

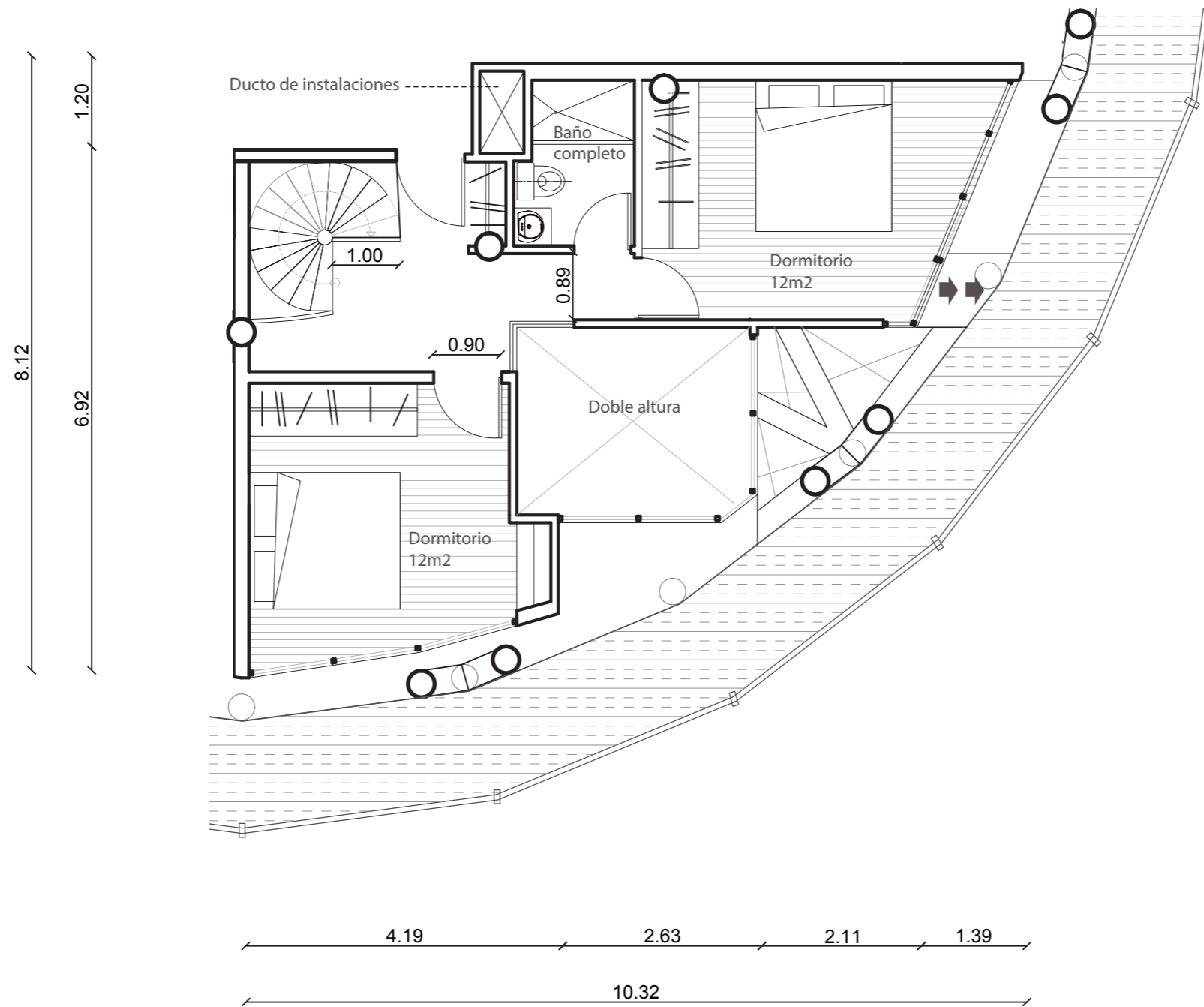

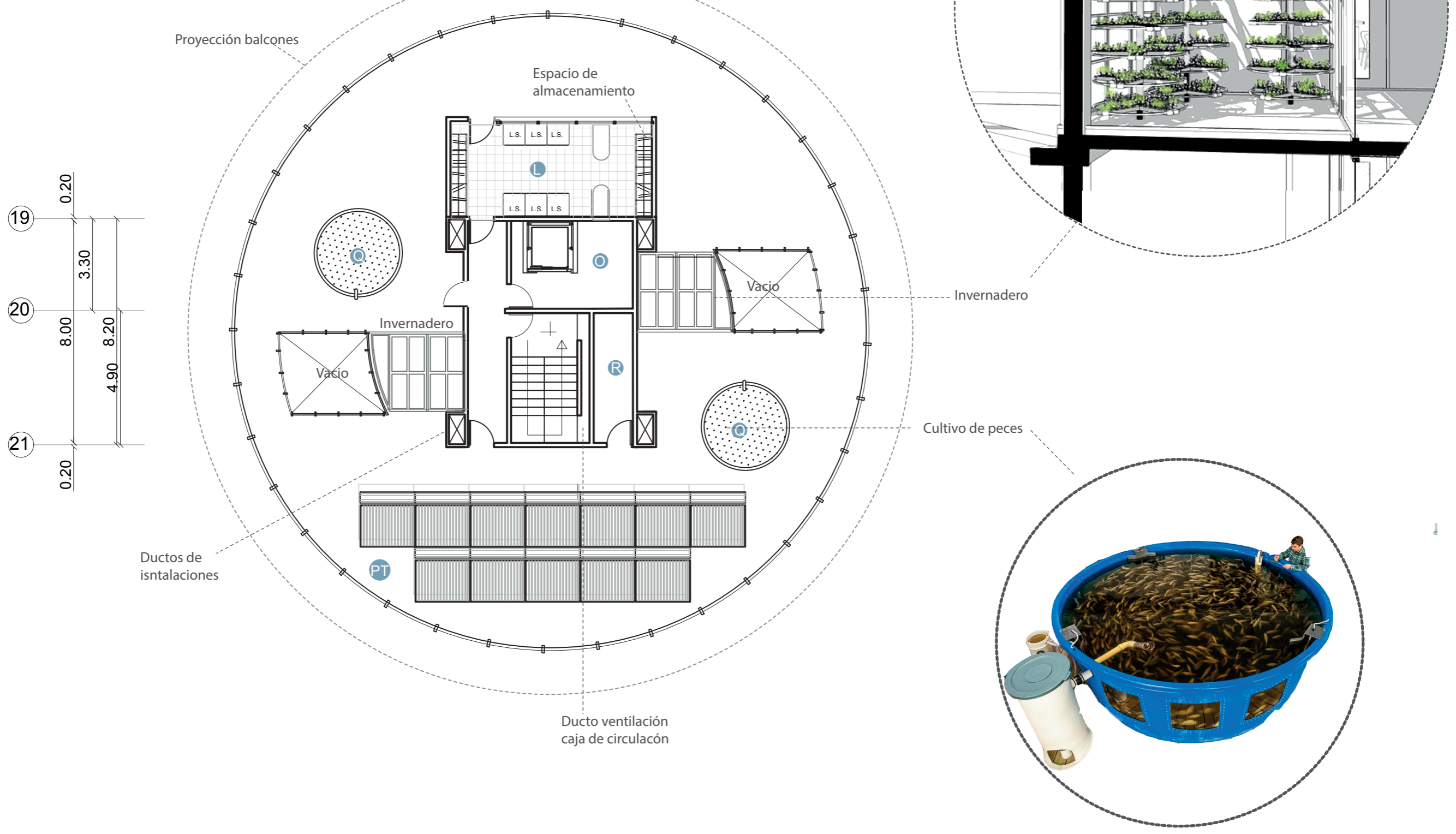
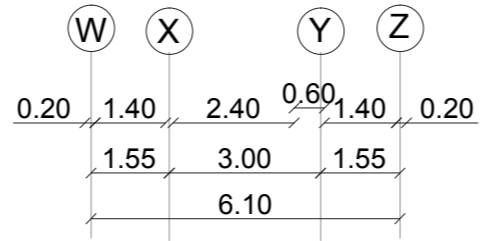

Cultivo de cepellones
Espacios de apoyo
comunales.

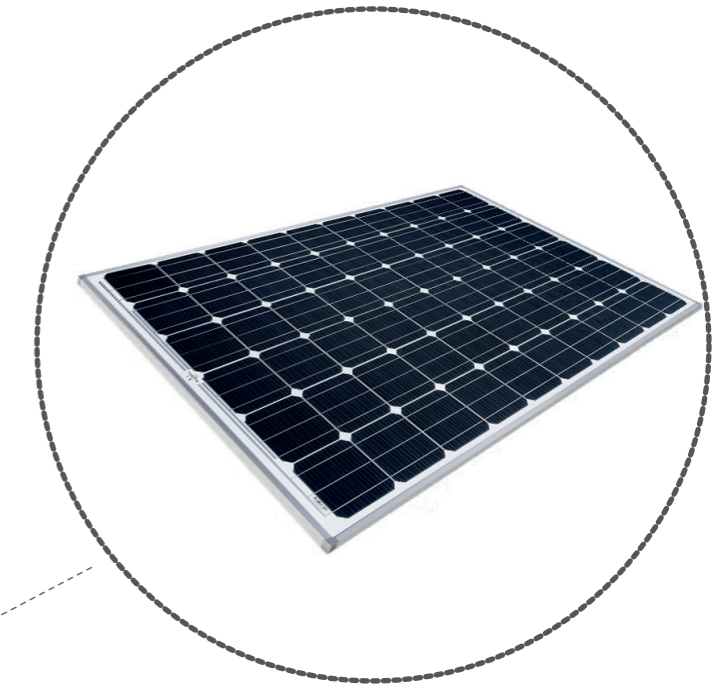
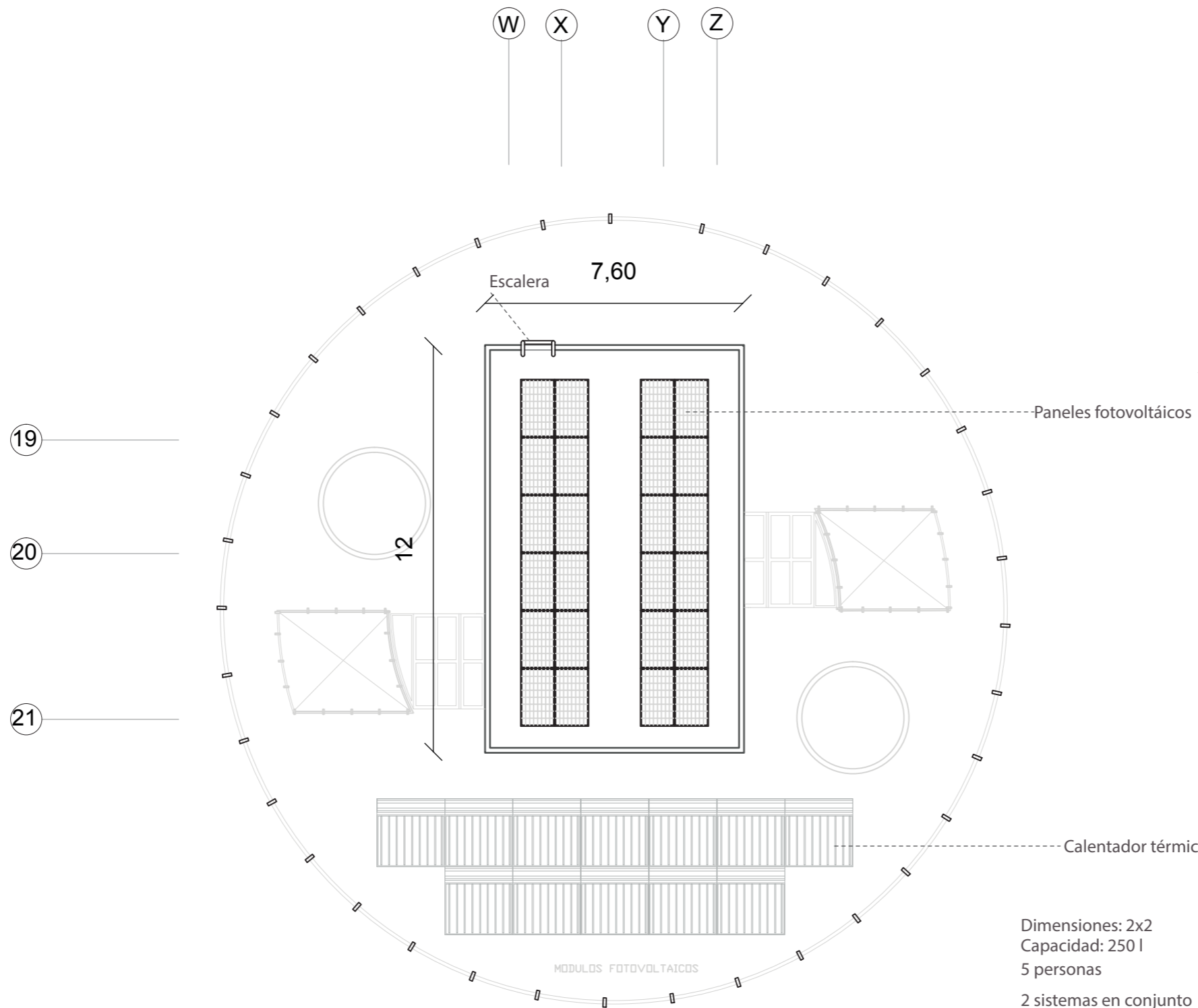

Dimensiones: 1x1.7
Potencia: 250w hora



Calentador térmico solar

Dimensiones: 2x2
Capacidad: 250 l
5 personas
2 sistemas en conjunto
12 personas

Tipología:
 Estudio, oficina.

Opciones de ocupación:

• Mesa rectangular

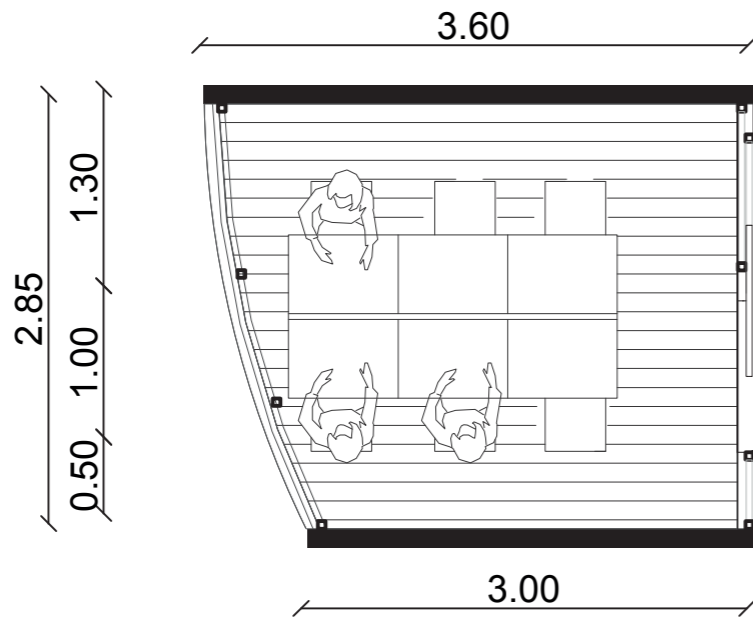

• Mesa perimetral

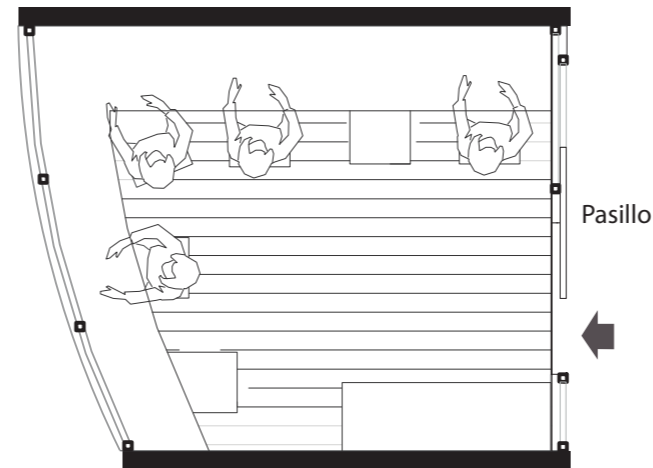

• Mesa central

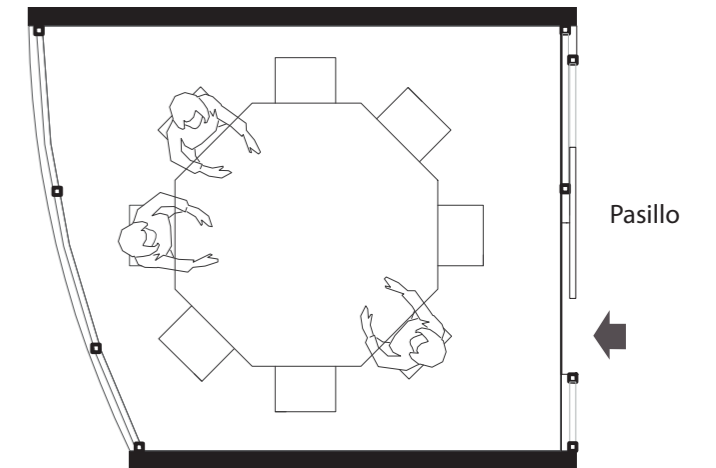

Perspectiva

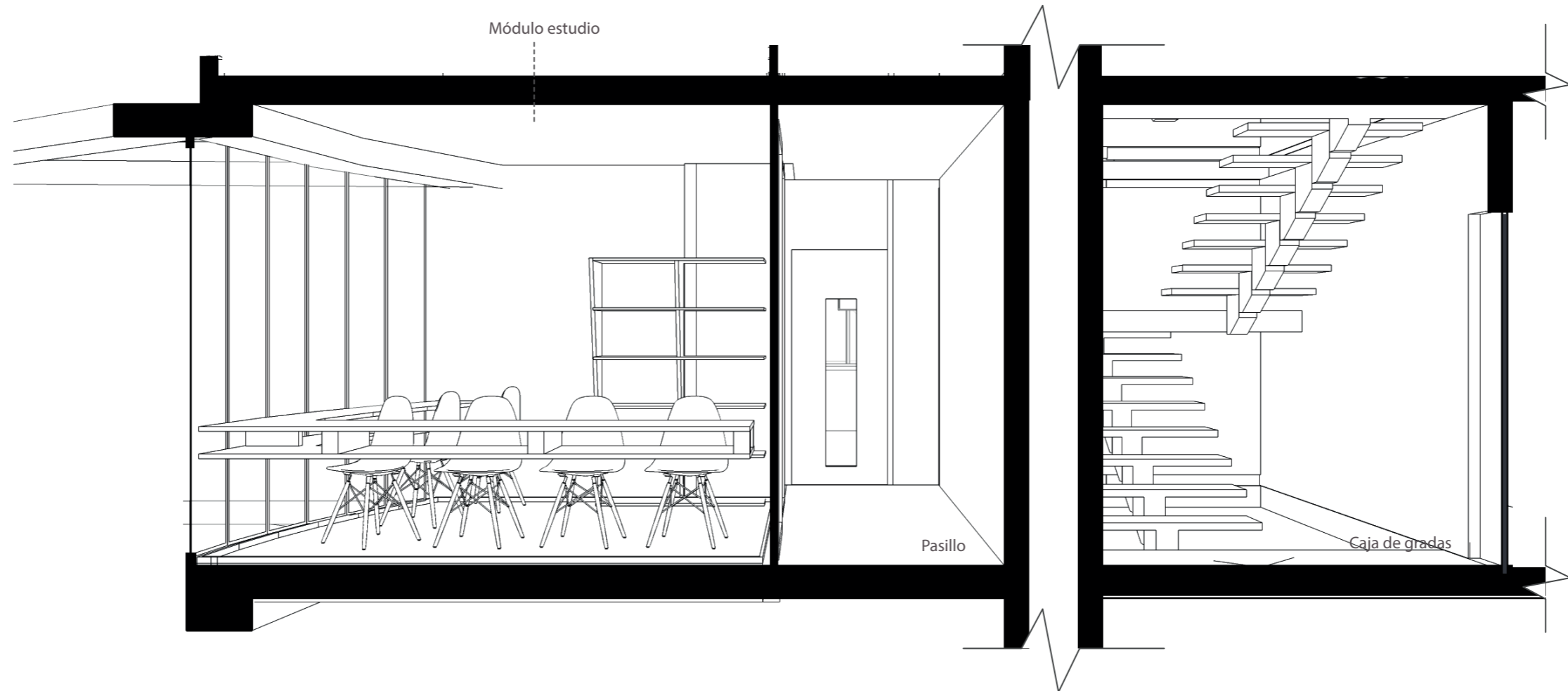

Tipología:
Ocio, entretenimiento

Opciones de ocupación:

- Terraza interna/externa + mesa picnic

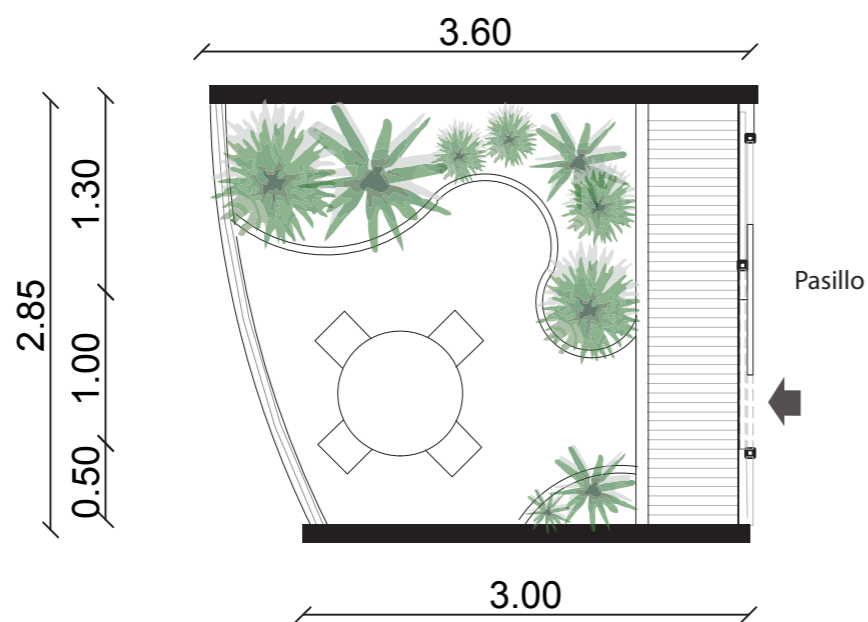

- Cuarto de TV.

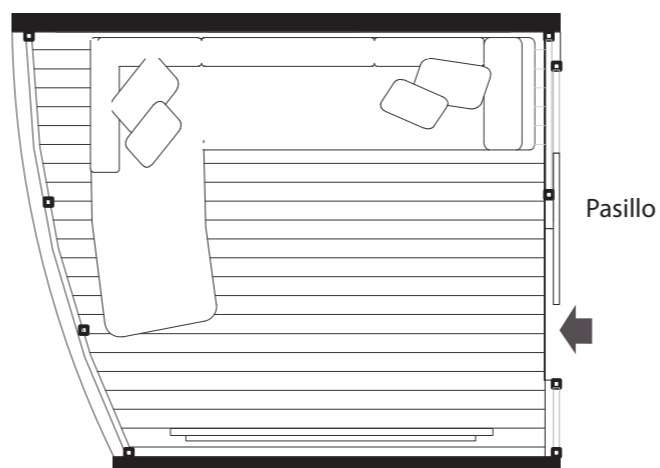

- Espacio de meditación

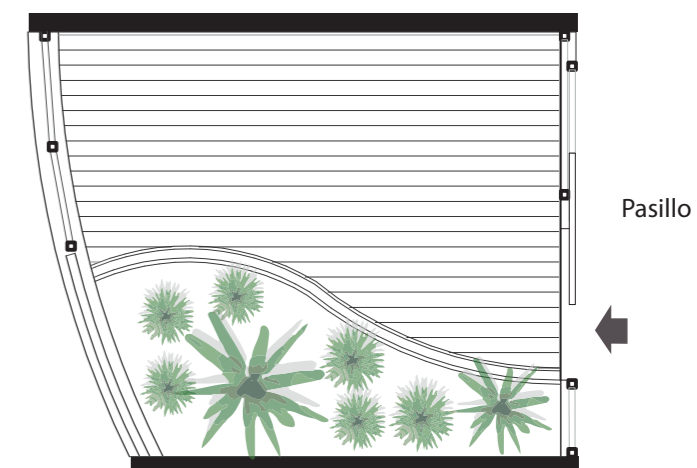

Espacio exterior, doble altura

Espacios de entretenimiento, ocio.

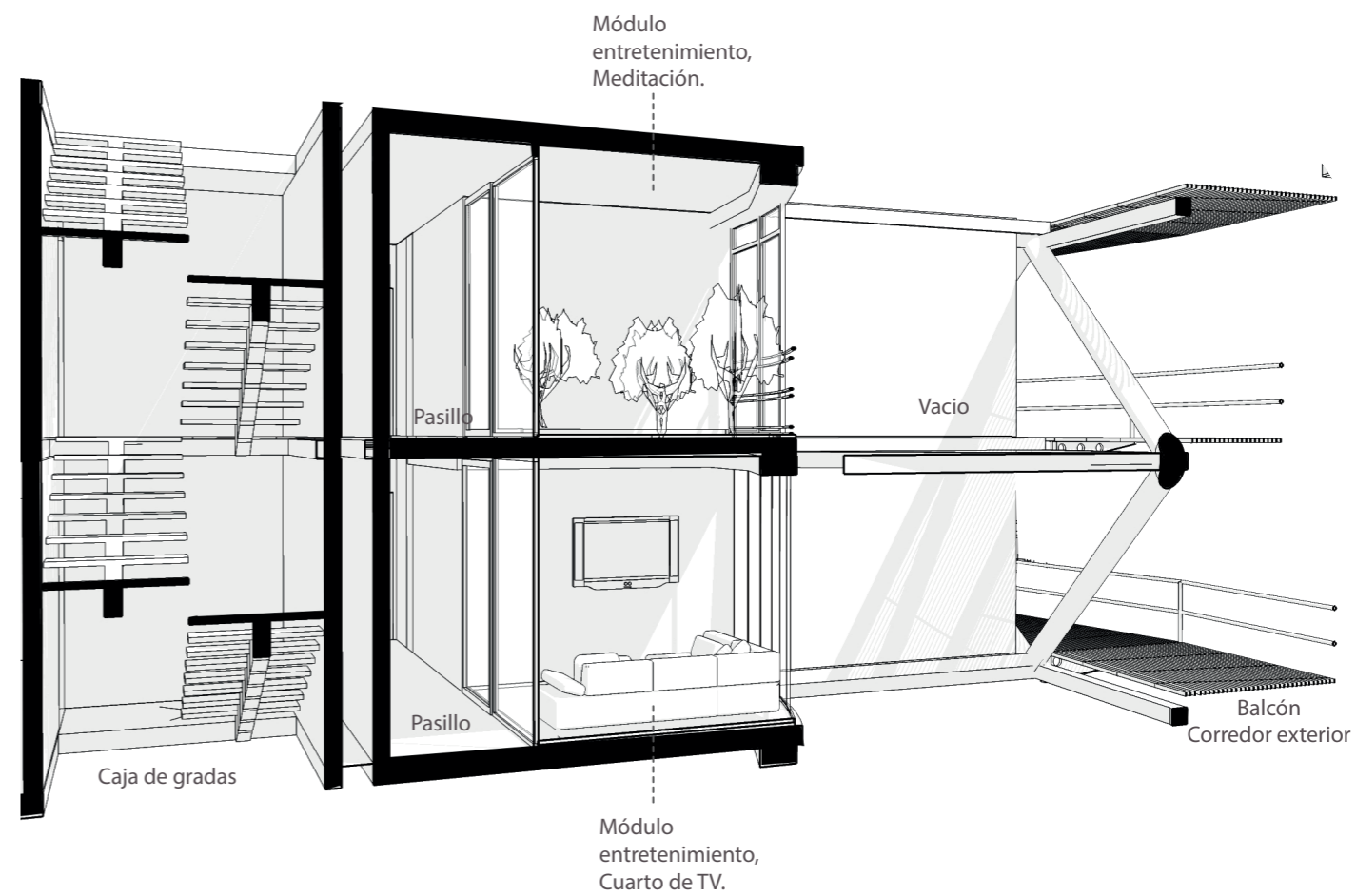
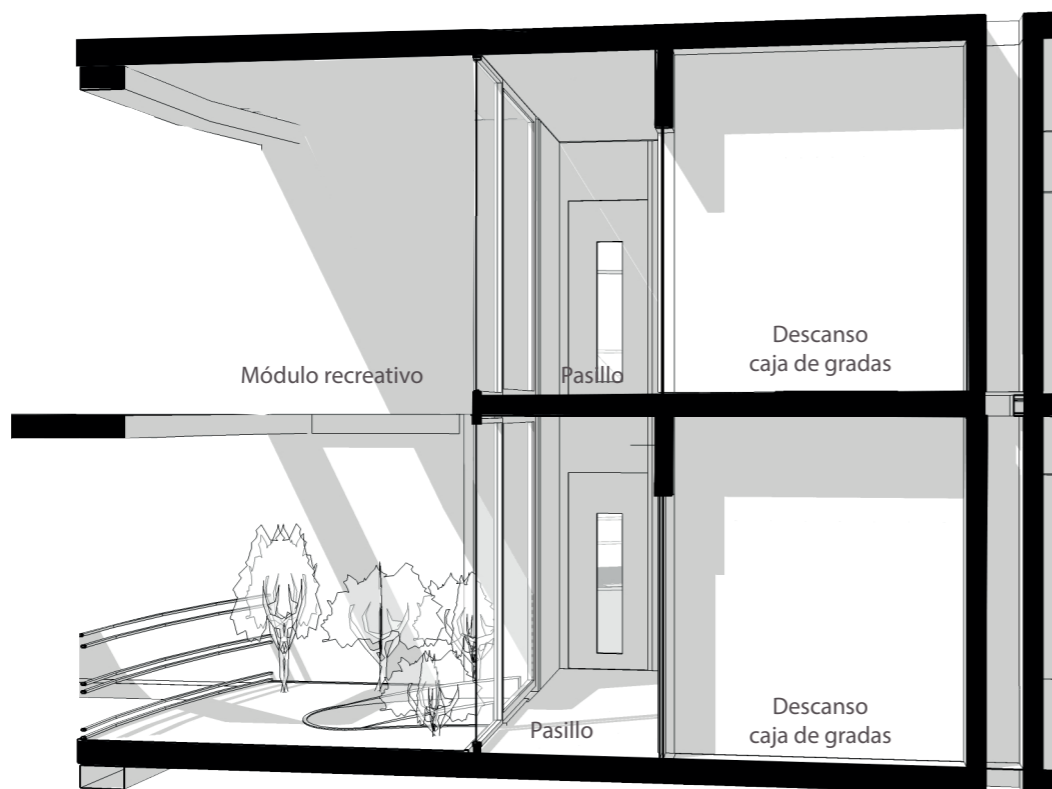

Tipología:
 Invernaderos.

Estos módulos únicamente se emplazan en últimos pisos

Opciones de ocupación:

- Cultivo de hortalizas.

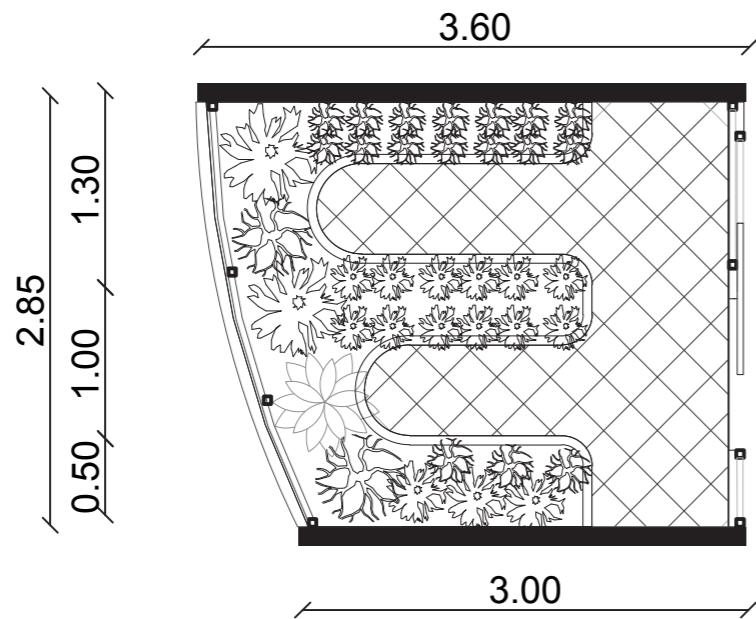

- Cultivo de cepellones

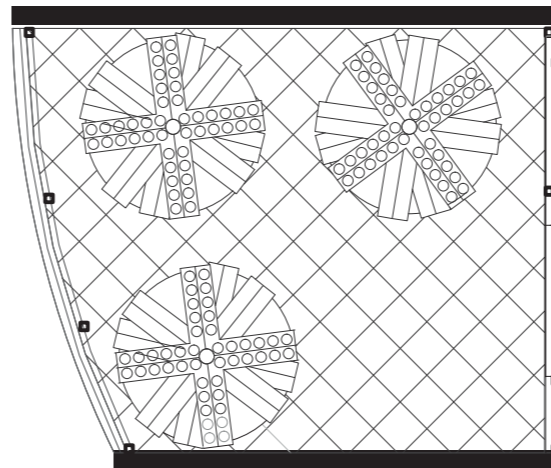

- Mixto, hortalizas y cepellones

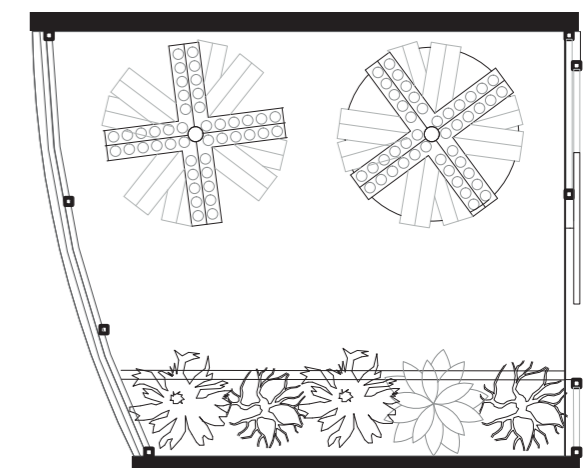

Espacios de entretenimiento, ocio.

Detalle, cultivo de cepellones.

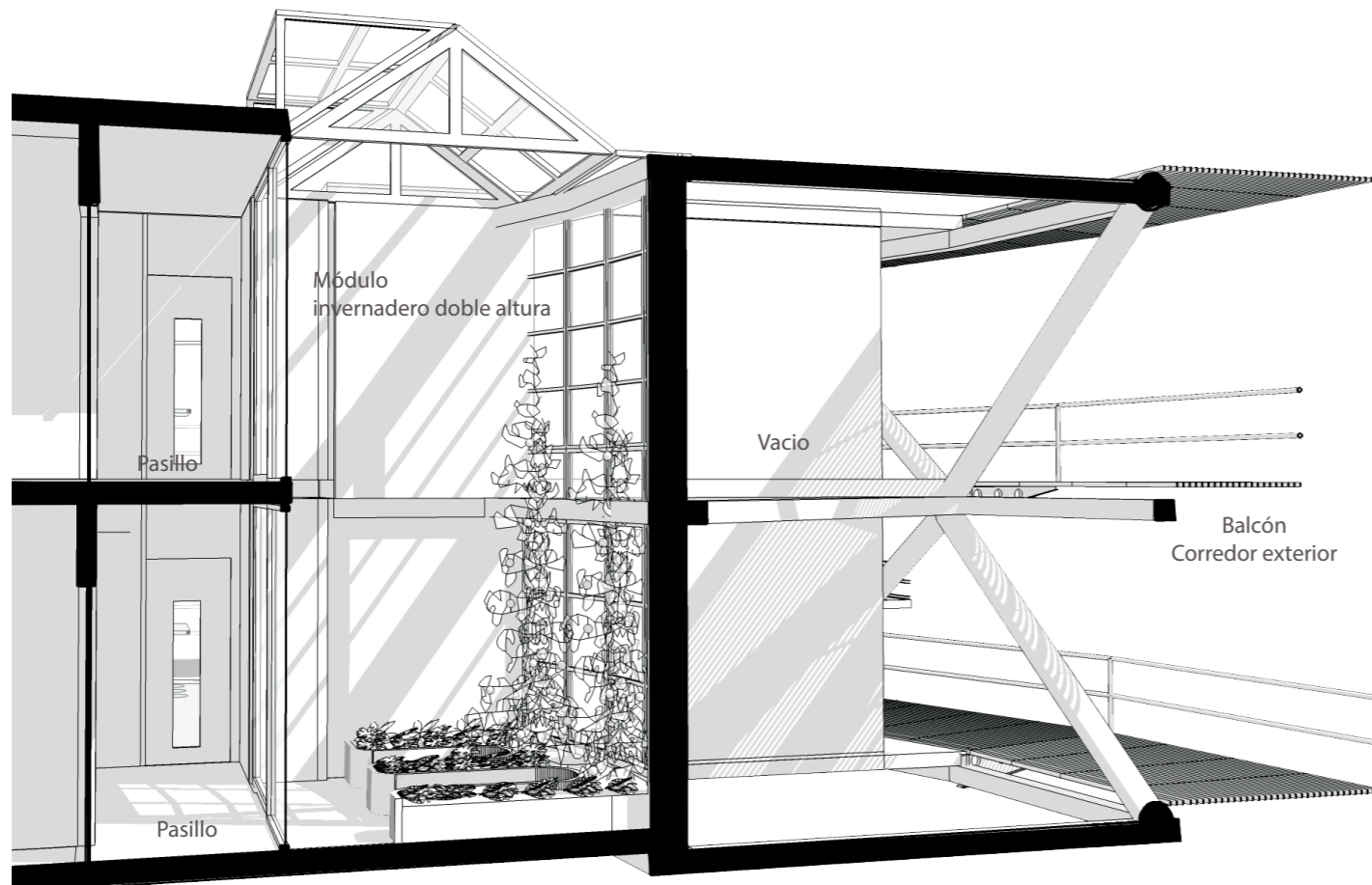

Estructura rotativa.
 40 cepellones por piso
 Capacidad de 280 plantulas

